

# Querschnitte. Cross Sections.

## DAF

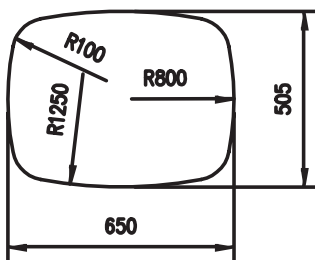

Material: Aluminium  
Querschnitt/Cross section: 675

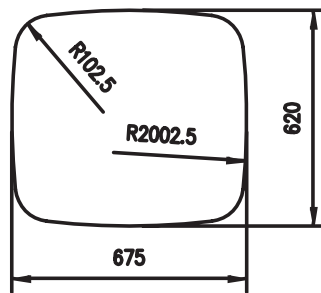

Material: Aluminium  
Querschnitt/Cross section: 872

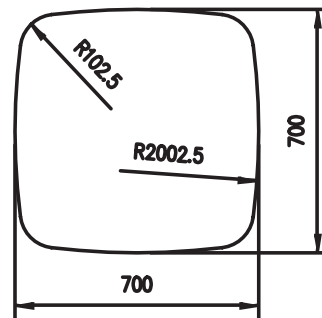

Material: Aluminium  
Querschnitt/Cross section: 953

## Iveco

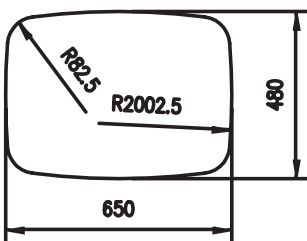

Material: Aluminium  
Querschnitt/Cross section: 921

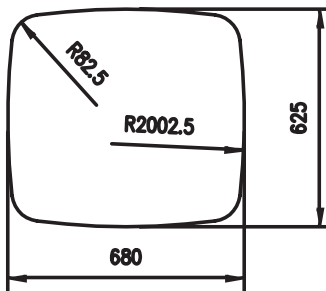

Material: Aluminium  
Querschnitt/Cross section: 922

## MAN

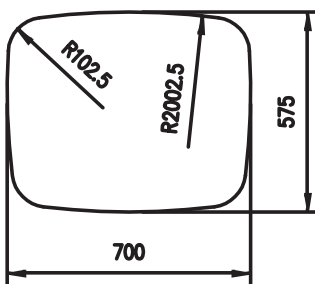

Material: Aluminium  
Querschnitt/Cross section: 991

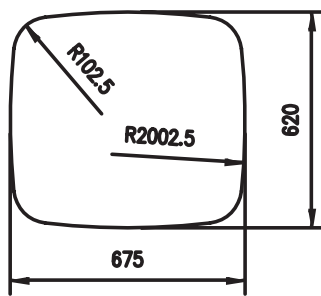

Material: Aluminium  
Querschnitt/Cross section: 872

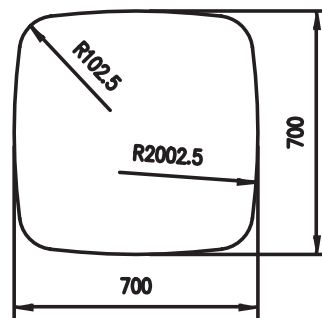

Material: Aluminium  
Querschnitt/Cross section: 953

## Mercedes Benz

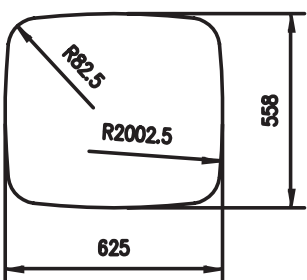

Material: Aluminium  
Querschnitt/Cross section: 824

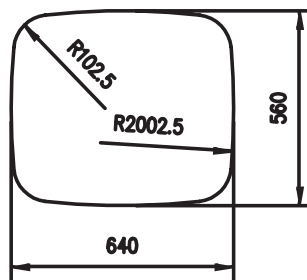

Material: Aluminium  
Querschnitt/Cross section: 931

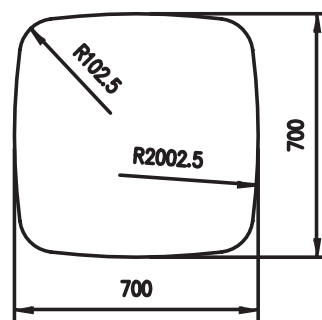

Material: Aluminium  
Querschnitt/Cross section: 963

# Querschnitte. Cross Sections.

## Universal

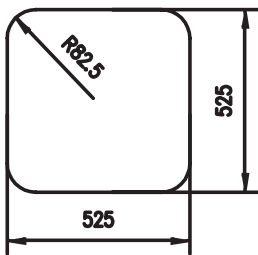

Material: Aluminium  
Querschnitt/Cross section: 821

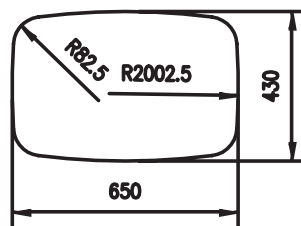

Material: Aluminium  
Querschnitt/Cross section: 881

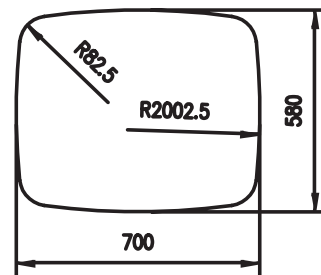

Material: Aluminium  
Querschnitt/Cross section: 923

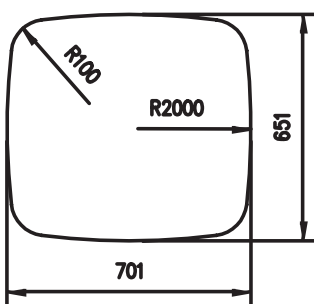

Material: Aluminium  
Querschnitt/Cross section:

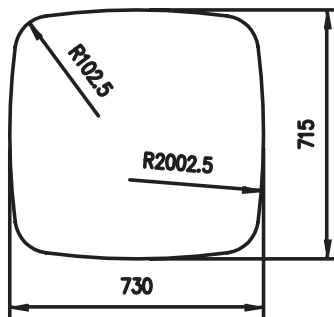

Material: Aluminium  
Querschnitt/Cross section: 501

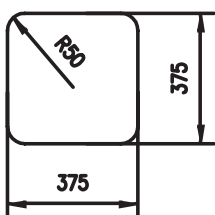

Material: Stahl/Steel

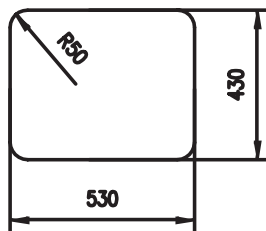

Material: Stahl/Steel

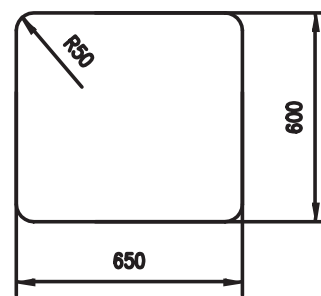

Material: Stahl/Steel

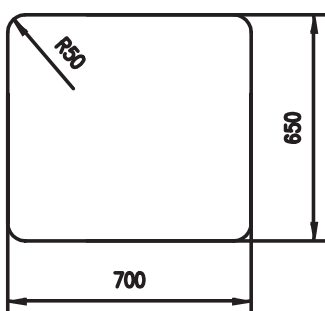

Material: Stahl/Steel

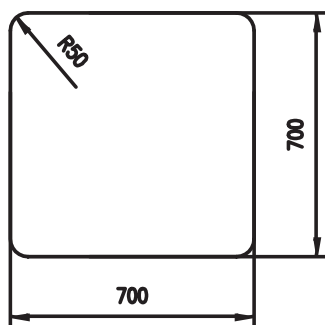

Material: Stahl/Steel